

This manual is for reference and historical purposes, all rights reserved.

This creation is copyright© by M. Butkus, NJ, U.S.A.

These creations may not be sold or distributed without the expressed permission of the producer

I have no connection with any camera company

### On-line camera manual library

If you find this manual useful, how about a donation of \$2 to:

M. Butkus, 29 Lake Ave., High Bridge, NJ 08829-1701

and send your e-mail address so I can thank you.

Most other places would charge you \$7.50 for a electronic copy or

\$18.00 for a hard to read Xerox copy.

**This will allow me to continue this site, buy new manuals and pay their shipping costs.**

**It'll make you feel better, won't it?**

**If you use Pay Pal, go to my web site**

**[www.orphancameras.com](http://www.orphancameras.com) and choose the secure PayPal donation icon.**

YOUR CAMERA - A ZEISS IKON CAMERA



ZEISS IKON CAMERAS

1 3/4 x 2 1/4"

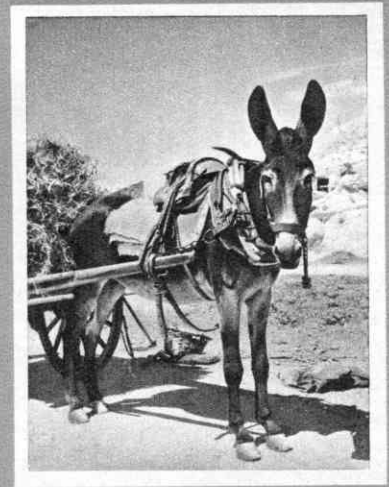

24x36 mm.



2 1/4 x 3 1/4"



2 1/4 x 2 1/4"

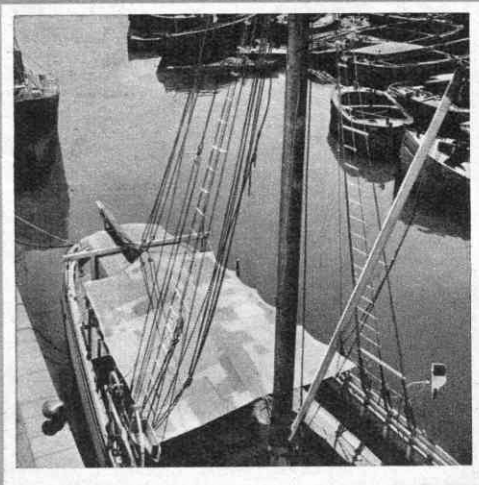

Photography will give you many happy hours of relaxation from the rush of your working day. And nearly everyone likes to specialise in his pet subject. Some prefer to take pictures of children, others of landscapes, sports or close-ups.

ZEISS IKON cameras will meet all your needs. You will find a model to suit you in every format and in every price range. No other camera manufacturer in the whole of the world covers so wide a field as ZEISS IKON.

Every camera is a thoroughly tried product of years of experience and is manufactured with the greatest possible care. ZEISS IKON cameras are world famous because of their precision.



# CONTENTS

PICTURE SIZES . . . . .	2/3
LENSES AND SHUTTERS . . . . .	4
BOX TENGOR 2 1/4 x 3 1/4" . . . . .	5
NETTAR 2 1/4 x 2 1/4", 2 1/4 x 3 1/4" . . . . .	6/7
IKONTA M 2 1/4 x 2 1/4", 2 1/4 x 3 1/4", IKONTA 1 3/4 x 2 1/4" . . . . .	8/9
SUPER IKONTA 1 3/4 x 2 1/4", 2 1/4 x 2 1/4", models I, II, III; 2 1/4 x 3 1/4" . . . . .	10/11
IKOFLEX Ia and IIa 2 1/4 x 2 1/4" . . . . .	12/13
CONTINA I and II 24 x 36 mm. . . . .	14
CONTESSA 24 x 36 mm. . . . .	15
CONTAFLEX 24 x 36 mm. . . . .	16/17
CONTAX IIa and IIIa 24 x 36 mm. . . . .	18/19
THE HORIZONTAL MOVIKON 8 . . . . .	20/21
IKOBLITZ, MOVILUM, IKOTRON . . . . .	22
IKOPHOT . . . . .	23
OTHER ACCESSORIES . . . . .	24



A photo-electric exposure meter is an indispensable aid especially in colour photography.

IKOPHOT . . . . .	23
A few remarks on ACCESSORIES . . . . .	24

With 35 mm. film you have up to 36 pictures per load. So you can afford to take your subject from many angles, and enlarge just the best shot afterwards.

CONTINA . . . . .	Page 14	CONTESSA . . . . .	Page 15
CONTAFLEX . . . . .	16	CONTAX . . . . .	18

This is a really economical size—you will get 16 negatives on every standard 2 1/4 x 3 1/4" roll film. Yet the contact prints are still large enough for your album.

IKONTA . . . . .	8	SUPER IKONTA . . . . .	10
------------------	---	------------------------	----

With a square picture it doesn't matter which way up you hold the camera—you just enlarge whatever part of the negative you want.

NETTAR . . . . .	6	IKONTA M . . . . .	8
SUPER IKONTA . . . . .	10	IKOFLEX . . . . .	12

This popular size gives you 8 pictures on a roll film—just enough for your week-end outing. The contact prints are of ideal album size.

BOX TENGOR . . . . .	5	NETTAR . . . . .	6
IKONTA M . . . . .	8	SUPER IKONTA . . . . .	10

Filming has its special attraction—You can capture and relive the thrill of real movement. Yet filming with an 8 mm. camera is even simpler than photography.

THE HORIZONTAL MOVIKON 8 . . . . .	20
------------------------------------	----

When it gets too dark for photography by daylight you can use lamps or flash.

IKOBLITZ . . . . .	22	MOVILUM . . . . .	22
IKOTRON . . . . .	22		

24 x 36

1 3/4 x 2 1/4"

2 1/4 x 2 1/4"

2 1/4 x 3 1/4"

8 mm.

PRONTOR-SV-Shutter

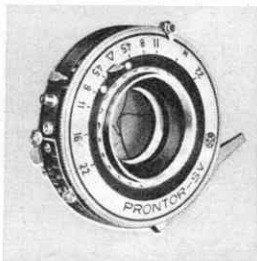

PRONTO-Shutter

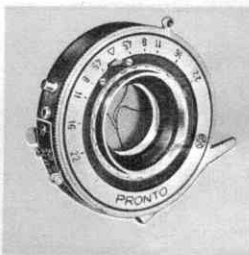

VELIO-Shutter

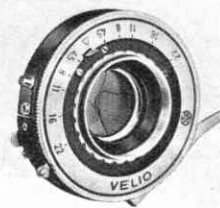

SYNCHRO-COMPUR-Shutter

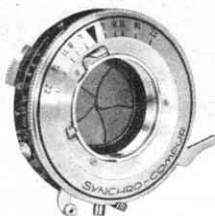

ZEISS IKON cameras are famous the world over, chiefly for their outstanding lenses. The NOVAR with an aperture of  $f/6.3$ ,  $f/4.5$  or  $f/3.5$  produces excellent black-and-white and colour pictures. The ZEISS TESSAR is often described as the "eagle eye" of any camera; its needle sharp definition has been proverbial for half a century. All lenses are coated and colour corrected. The choice of the shutter depends very much on the type of subject you wish to take. A sports shot, for example, will require a faster speed than a landscape. The following shutters are built into ZEISS IKON cameras:

Vario	$1/25$ , $1/75$ , $1/200$ sec., time
Vero	$1/25$ , $1/50$ , $1/100$ , $1/200$ sec., time
Velio	$1/10$ , $1/25$ , $1/50$ , $1/100$ , $1/200$ sec., time
Pronto	$1/25$ , $1/50$ , $1/100$ , $1/200$ sec., time, delayed action
Prontor-S	$1$ , $1/2$ , $1/5$ , $1/10$ , $1/25$ , $1/50$ , $1/100$ , $1/300$ sec. ( $1/250$ sec. with $2\frac{1}{4} \times 3\frac{1}{4}$ in. models), time, delayed action
Prontor-SV	like Prontor-S, but speed synchronised
Synchro-Compur	$1$ , $1/2$ , $1/5$ , $1/10$ , $1/25$ , $1/50$ , $1/100$ , $1/250$ , $1/500$ sec., time. Speed synchronised. (Has delayed action on all $2\frac{1}{4} \times 3\frac{1}{4}$ in. and some $2\frac{1}{4} \times 2\frac{1}{4}$ in. models)
Synchro-Compur MXV	$1$ , $1/2$ , $1/4$ , $1/6$ , $1/15$ , $1/30$ , $1/60$ , $1/125$ , $1/250$ , $1/500$ sec., time. Speed synchronised, delayed action

Focal Plane Shutter Speed synchronised to  $1/1250$  sec. Only available in the CONTAX (see page 18)

All shutters are provided with a flash contact. For high speed flash shots the shutter must be speed-synchronised. If you want to take self-portraits, choose a shutter with delayed action.

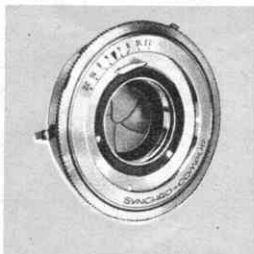
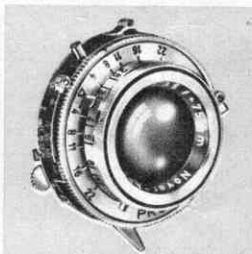
SYNCHRO-COMPUR-MXV  
Shutter

NOVAR



ZEISS TESSAR



# BOX TENGOR

With the BOX TENGOR you'll start taking good pictures straight away. It is so simple to use that you couldn't go wrong.

The BOX TENGOR is the ideal camera for a beginner. Even a child can use it. Its indestructible light-metal body will stand more than an occasional knock.

Important BOX TENGOR features for the beginner are the double exposure lock, the safety catch against accidental release and the warning signal to prevent unexposed shots. However careless you may be, you just couldn't take that lovely view in front if you mixed up with the trellis fence of the previous shot.



2¼ x 3¼"

BOX TENGOR 2¼ x 3¼" (6 x 9 cm.). Dimensions: 4½ x 4½ x 2¾" (11.5 x 10.5 x 7.2 cm.), weight 19½ ounces (550 grams), Frontar f/9 lens, shutter for instantaneous and time exposures.

No. 56/2

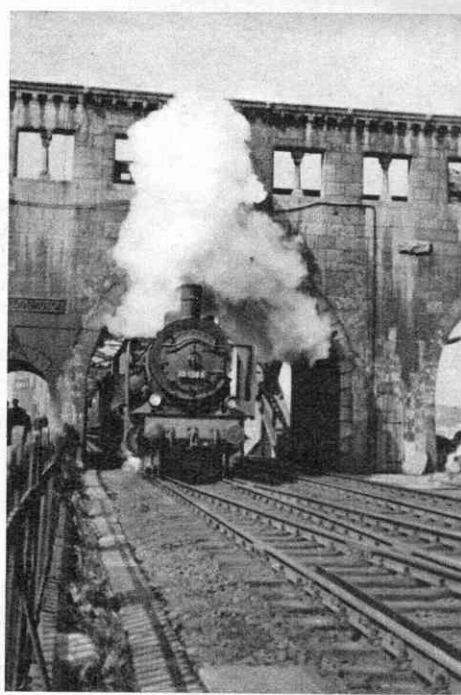

The BOX TENGOR has a colour-corrected and coated Frontar f/9 lens. This is fast enough for colour photography if the light is good. Everything more than 9 yards away will be sharp. But if you want to take groups from 2¼ to 9 yards, or portraits from 1 to 2 yards, a lever brings built-in close-up lenses into use. A second lever operates the lens stops.

The shutter permits instantaneous and time exposures. It has flash contacts built-in. Thus even flash shots are easy with the BOX TENGOR.

A cable release socket, upright and horizontal finders, a tripod bush and, if desired, a yellow push-on filter complete the equipment of this popular and efficient camera, which with its low price is within everybody's reach.

ACCESSORIES. ACCESSORIES. ACCESSORIES. ACCESSORIES. ACCESSORIES. ACCESSORIES.

Ever-ready case  
Push-on yellow filter  
Cable release with lock

No. 1227/2  
No. 347  
No. 1312/24

# NETTAR

The NETTAR is the ideal camera for week-end trips and holidays. It folds up and is easily carried in a rucksack or coat pocket whilst hiking, climbing or ski-ing. The lens and shutter are protected all the time. You just press a button and the camera is ready to shoot. Sight the subject through the large bright optical finder, press the convenient body-release, and a live picture is captured for ever.

The NETTAR is so popular because of its technical features. The efficient NOVAR lenses are equally good for black-and-white and colour. A depth-of-field indicator, flash contacts (speed synchronised on some of the models), a tripod bush, an accessory shoe and a cable release socket further extend the scope. The metal parts of the smart body are chromium plated. Like all ZEISS IKON cameras the NETTAR has convenient red-dot settings. If distance and aperture are set to the red dots then everything over 12 ft away will be sharp. This allows sufficient depth for any unexpected subject that may come your way. You can also close the NETTAR in this position and you thus have an ideal snapshot camera.

The SIGNAL NETTAR has been designed for those who want a really foolproof camera. It has a double-exposure lock and a transport signal which warns you while the film is still un-exposed.

Different NETTAR and SIGNAL NETTAR models are available for  $2\frac{1}{4} \times 2\frac{1}{4}$  in. or  $2\frac{1}{4} \times 3\frac{1}{4}$  in. pictures. If you are after a camera in this price range, you are sure to find a NETTAR to suit you.

## NETTAR $2\frac{1}{4} \times 2\frac{1}{4}$ " (6x6 cm.):

Dimensions:  $5\frac{1}{8} \times 4 \times 1\frac{1}{4}$ " (13.5x10x4.3 cm.).

Weight 19½ ounces (550 grams).

Lens	Shutter	No.
Novar f/6.3 3" (75 mm.)	Vario	517/16 Ev

## SIGNAL NETTAR $2\frac{1}{4} \times 2\frac{1}{4}$ " (6x6 cm.):

Dimensions and weight as above.

Lens	Shutter	No.
Novar f/6.3 3" (75 mm.)	Vero	518/16 Eg
Novar f/4.5 3" (75 mm.)	Velio	518/16 lh
Novar f/4.5 3" (75 mm.)	Pronto	518/16 Its
Novar f/4.5 3" (75 mm.)	Prontor-S	518/16 Ips
Novar f/4.5 3" (75 mm.)	Prontor-SV	518/16 Ipms
Novar f/3.5 3" (75 mm.)	Prontor-S	518/16 Fps
Novar f/3.5 3" (75 mm.)	Prontor-SV	518/16 Fpms

## SIGNAL NETTAR $2\frac{1}{4} \times 3\frac{1}{4}$ " (6x9 cm.):

Dimensions:  $6\frac{1}{2} \times 4 \times 1\frac{1}{4}$ " (16.5x10x4.5 cm.).

Weight 27 ounces (770 grams).

Lens	Shutter	No.
Novar f/6.3 $4\frac{1}{8}$ " (105 mm.)	Vero	518/2 Eg
Novar f/4.5 $4\frac{1}{8}$ " (105 mm.)	Velio	518/2 lh
Novar f/4.5 $4\frac{1}{8}$ " (105 mm.)	Pronto	518/2 Its
Novar f/4.5 $4\frac{1}{8}$ " (105 mm.)	Prontor-S	518/2 Ips
Novar f/4.5 $4\frac{1}{8}$ " (105 mm.)	Prontor-SV	518/2 Ipms
Novar f/3.5 $4\frac{1}{8}$ " (105 mm.)	Prontor-S	518/2 Fps
Novar f/3.5 $4\frac{1}{8}$ " (105 mm.)	Prontor-SV	518/2 Fpms

ACCESSORIES . ACCESSORIES . ACCESSORIES . ACCESSORIES . ACCESSORIES . ACCESSORIES . ACCESSORIES . ACCESSORIES . ACCESSORIES . ACCESSORIES .

### ACCESSORIES:

	$2\frac{1}{4} \times 2\frac{1}{4}$ " (6x6 cm.)	$2\frac{1}{4} \times 3\frac{1}{4}$ " (6x9 cm.)
Ever-ready case	No. 1231/16	1234/2
ZEISS IKON precision filters in 6 colours	349, 353	349, 354
Polarising filter ZEISS BERNOTAR	330	330, 331
Lens hood	1111	1111, 1112, 1113
Leather case for lens hood	779	779, 780

### ZEISS PROXAR-lenses

	$2\frac{1}{4} \times 2\frac{1}{4}$ " (6x6 cm.)	$2\frac{1}{4} \times 3\frac{1}{4}$ " (6x9 cm.)
for close-ups down to 40" (100 cm.)	No. —	910/2, 911/2, 912/2
for close-ups down to 20" (50 cm.)	910/1	910/1, 911/1, 912/1
for close-ups down to 12" (30 cm.)	910/05	910/05, 911/05, 912/05
Cable release with lock	1312/24	1312/24
IKOPHOT exposure meter (see page 23)	1329	1329

2¼ x 3¼"



2¼ x 2¼"

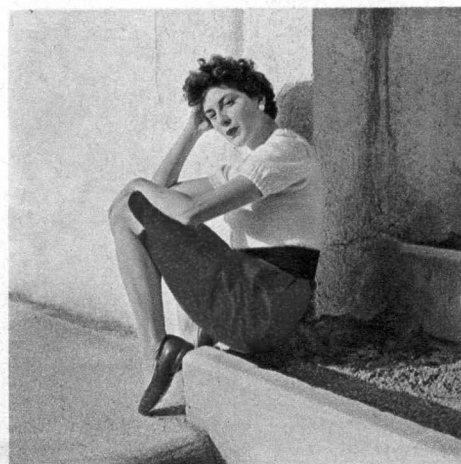



# IKONTA M AND IKONTA



IKONTA M

 $2\frac{1}{4} \times 2\frac{1}{4}$ "

IKONTA M  $2\frac{1}{4} \times 2\frac{1}{4}$ " (6 x 6 cm.):  
 Dimensions:  $5\frac{3}{8} \times 4 \times 1\frac{3}{4}$ " (13.5 x 10 x 4.5 cm.)  
 Weight  $22\frac{1}{2}$  ounces (640 grams)

Lens	Shutter	No.
Novar f/4.5 3" (75 mm.)	Prontor-SV	524/16 Ipms
Novar f/3.5 3" (75 mm.)	Prontor-SV	524/16 Fpms
Tessar f/3.5 3" (75 mm.)	Synchro-Compur	524/16 Lcm

Even a ZEISS lens cannot produce a sharp picture if it's not focused right. You steer clear of that problem with the IKONTA M which has a built-in rangefinder. The distance is quickly measured by turning a handy knob. You can make the most of your lens speed, there is no need to stop down for safety. The subject stands out clearly against the blurred background so that the pictures really gain in depth. The rangefinder and viewfinder have separate eyepieces to make the image in the rangefinder as large as possible. This makes for greater accuracy in measuring.

The IKONTA M is specially suitable for colour photography. Despite the larger aperture needed for the slow colour film, you always get pin-sharp pictures. The rangefinder looks after your focusing problems, while the colour corrected lenses ensure correct colour rendering. A film indicator shows the negative material loaded in the camera. If you are after the higher lens quality you can also get the IKONTA M with the world famous ZEISS TESSAR. Apart from that the technical equipment of the IKONTA M is similar to that of the SIGNAL NETTAR: it has an optical finder, spring opening mechanism, double-exposure lock, body release, red-dot setting, depth-of-field scale, tripod bush and cable release socket. The shutters are speed synchronised. All Prontor-SV models and all  $2\frac{1}{4} \times 3\frac{1}{4}$  in. (6 x 9 cm.) cameras are equipped with a delayed action release.

ACCESSORIES . ACCESSORIES . ACCESSORIES . ACCESSORIES . ACCESSORIES . ACCESSORIES . ACCESSORIES . ACCESSORIES . ACCESSORIES . ACCESSORIES . ACCESSORIES .

## ACCESSORIES:

	$1\frac{3}{4} \times 2\frac{1}{4}$ " (4.5 x 6 cm., 6 x 6 cm.)	$2\frac{1}{4} \times 2\frac{1}{4}$ " (6 x 6 cm.)	$2\frac{1}{4} \times 3\frac{1}{4}$ " (6 x 9 cm.)
Ever-ready case	No. 1208, 1231/16	1236/2	
ZEISS IKON precision filters			
in 6 colours	353	354	
Polarising filter ZEISS BERNOTAR	330	331	
Lens hood	1111	1112, 1113	
Leather case for lens hood	779	780	
Cable release with lock	1312/24	1312/24	

## ZEISS PROXAR lenses

	$1\frac{3}{4} \times 2\frac{1}{4}$ " (4.5 x 6 cm., 6 x 6 cm.)	$2\frac{1}{4} \times 2\frac{1}{4}$ " (6 x 6 cm.)	$2\frac{1}{4} \times 3\frac{1}{4}$ " (6 x 9 cm.)
for close-ups down to 40" (100 cm.)	—	—	No. 911/2, 912/2
for close-ups down to 20" (50 cm.)	910/1	—	911/1, 912/1
for close-ups down to 12" (30 cm.)	910/05	—	911/05, 912/05
IKOPHOT exposure meter (see page 23)	1329	1329	
For $1\frac{3}{4} \times 2\frac{1}{4}$ " (4.5 x 6 cm.) IKONTA Push-on brilliant finder	437		

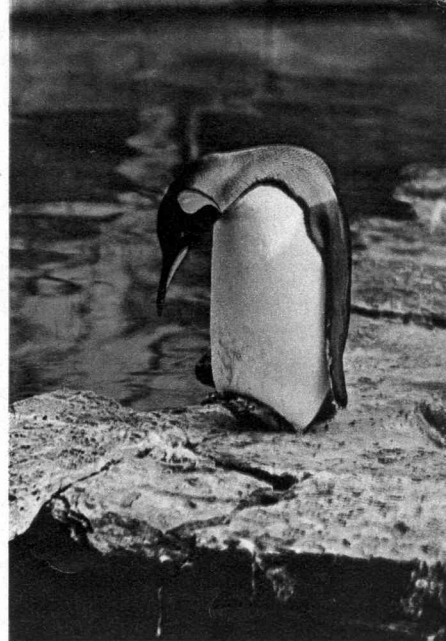
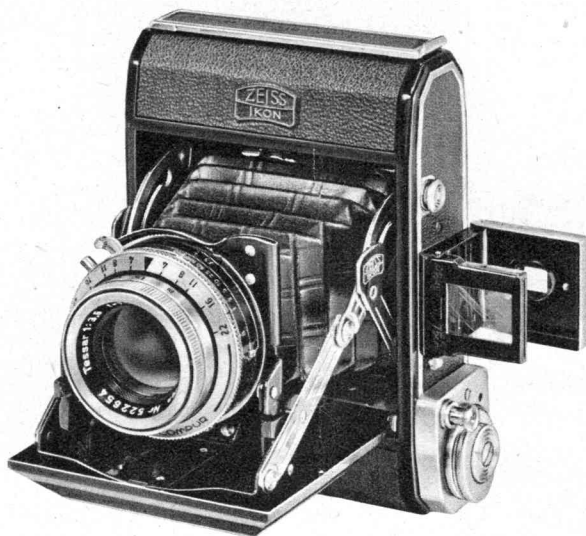
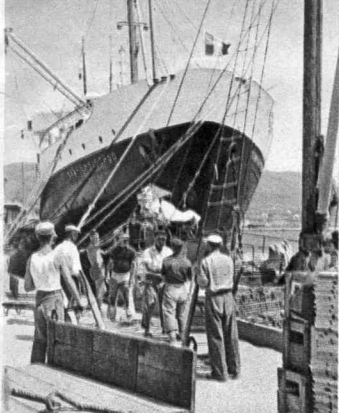

IKONTA  $1\frac{3}{4} \times 2\frac{1}{4}$ "

The same camera, but without a rangefinder is available under the name of IKONTA. There is also a model for 16 exposures  $1\frac{3}{4} \times 2\frac{1}{4}$ " (4.5 x 6 cm.) for those who prefer this size.

**IKONTA  $1\frac{3}{4} \times 2\frac{1}{4}$ "**

(4.5 x 6 cm.):  
Dimensions:  $4\frac{1}{2} \times 3\frac{1}{8} \times 1\frac{1}{2}$ "  
(11.3 x 7.8 x 3.8 cm.)  
Weight:  $16\frac{1}{4}$  ounces (460 grams)

Lens	Shutter	No.
Novar f/4.5 3" (75 mm.)	Prontor-SV	521 Ipms
Novar f/3.5 3" (75 mm.)	Prontor-SV	521 Fpms
Tessar f/3.5 3" (75 mm.)	Synchro-Compur	521 Lcm

**IKONTA  $2\frac{1}{4} \times 2\frac{1}{4}$ "**

(6 x 6 cm.):  
Dimensions:  $5\frac{9}{8} \times 4 \times 1\frac{3}{8}$ "  
(13.5 x 10 x 4.5 cm.)  
Weight:  $22\frac{1}{2}$  ounces (640 grams)

Novar f/4.5 3" (75 mm.)	Prontor-SV	523/16 Ipms
Novar f/3.5 3" (75 mm.)	Prontor-SV	523/16 Fpms
Tessar f/3.5 3" (75 mm.)	Synchro-Compur	523/16 Lcm

**IKONTA  $2\frac{1}{4} \times 3\frac{1}{4}$ "**

(6 x 9 cm.):  
Dimensions:  $6\frac{1}{2} \times 4 \times 1\frac{3}{8}$ "  
(16.5 x 10 x 4.5 cm.)  
Weight: 30 ounces (850 grams)

Novar f/4.5 $4\frac{1}{8}$ " (105 mm.)	Prontor-SV	523/2 Ipms
Novar f/3.5 $4\frac{1}{8}$ " (105 mm.)	Prontor-SV	523/2 Fpms
Tessar f/3.5 $4\frac{1}{8}$ " (105 mm.)	Synchro-Compur	523/2 Lcm

**IKONTA M  $2\frac{1}{4} \times 3\frac{1}{4}$ "**

(6 x 9 cm.):  
Dimensions:  $6\frac{1}{2} \times 4 \times 1\frac{3}{4}$ "  
(16.5 x 10 x 4.5 cm.)  
Weight: 30 ounces (850 grams)

Novar f/4.5 $4\frac{1}{8}$ " (105 mm.)	Prontor-SV	524/2 Ipms
Novar f/3.5 $4\frac{1}{8}$ " (105 mm.)	Prontor-SV	524/2 Fpms
Tessar f/3.5 $4\frac{1}{8}$ " (105 mm.)	Synchro-Compur	524/2 Lcms

IKONTA M  $2\frac{1}{4} \times 3\frac{1}{4}$ "



2¼ x 2¼"

SUPER IKONTA I

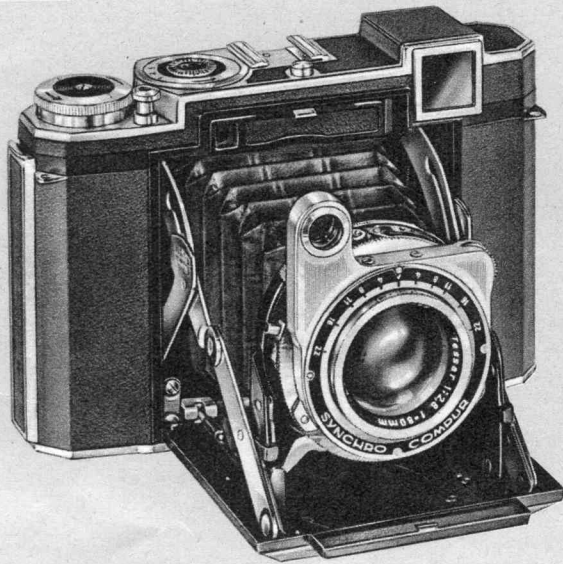

NEW

SUPER IKONTA III

2¼ x 2¼"



2¼ x 2¼"

SUPER IKONTA II

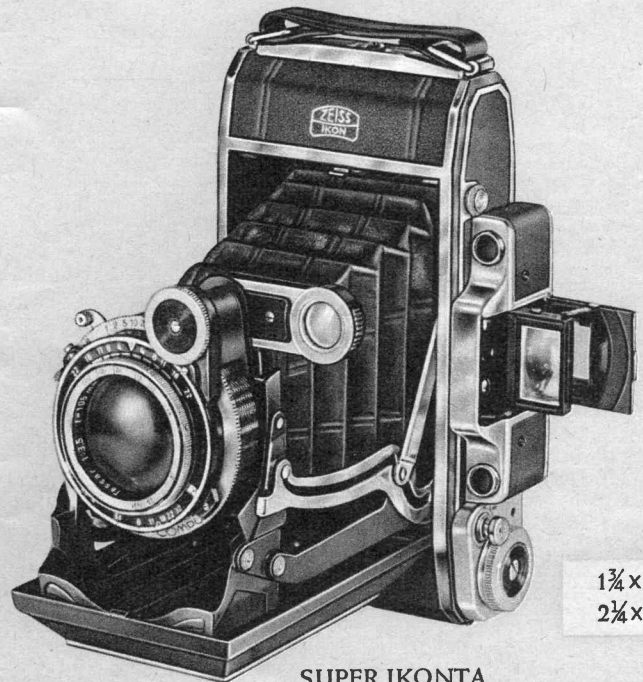
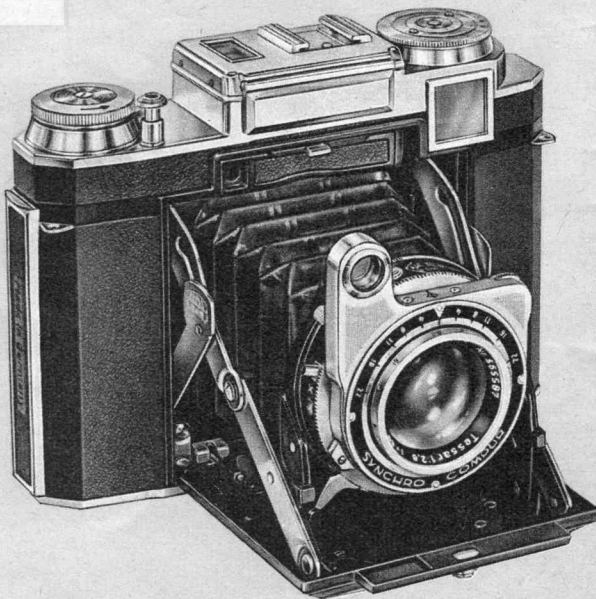

1¾ x 2¼"  
2¼ x 3¼"

SUPER IKONTA

# SUPER IKONTA



These roll-film cameras are in a class of their own. They have technical features which are usually found only on precision miniature cameras. The latest and finest in this range is the SUPER IKONTA III. It has a coupled rangefinder. You just rotate a ring to make the rangefinder images to coincide; this automatically focuses the lens. The SUPER IKONTA was designed to be instantly ready for action. The rangefinder and viewfinder are therefore combined in one eyepiece. Obviously the camera has a self-erecting baseboard, red-dot zone focus settings, etc. The film transport is noteworthy: you just turn the film winding knob as far as it will go. The film for the next exposure is then automatically in position. This works even for the first exposure so that the red window is unnecessary. In its place the camera is fitted with an automatic counter and an indicator showing whether the camera has been loaded or not.

If you want large aperture lenses, choose the SUPER IKONTA I. This is similar to the SUPER IKONTA III but is fitted with the exceptionally fast ZEISS TESSAR f/2.8 lens.

The SUPER IKONTA II is the crowning achievement of all roll-film cameras. It has a highly sensitive photo-electric exposure meter built-in to eliminate all possible exposure errors. It is the ideal camera for the colour photographer.

The SUPER IKONTA is available as a 1<sup>3</sup>/<sub>4</sub> x 2<sup>1</sup>/<sub>4</sub> in. (4.5 x 6 cm.) model, and also as a two size camera taking 2<sup>1</sup>/<sub>4</sub> x 3<sup>1</sup>/<sub>4</sub> in. (6 x 9 cm.) or 1<sup>3</sup>/<sub>4</sub> x 2<sup>1</sup>/<sub>4</sub> in. (4.5 x 6 cm.) pictures. These models also have a coupled rangefinder. The van Albada type viewfinder shows the picture outlined by a bright frame within a larger field of view. Moving subjects are therefore visible a

moment before they actually enter the picture area. This is a great help in sports photography. The many technical features of the SUPER IKONTA camera are described in a separate detailed pamphlet.

## SUPER IKONTA I 2<sup>1</sup>/<sub>4</sub> x 2<sup>1</sup>/<sub>4</sub>" (6 x 6 cm.)

Dimensions: 5<sup>1</sup>/<sub>4</sub> x 3<sup>1</sup>/<sub>4</sub> x 1<sup>1</sup>/<sub>8</sub>" (14.7 x 9.6 x 4.8 cm.) Weight: 35 ounces (1000 grams)

Lens	Shutter	No.
Tessar f/2.8 3 <sup>1</sup> / <sub>8</sub> " (80 mm.)	Synchro-Compur	532/16 Pcms
Ever-ready case		1204/16

## SUPER IKONTA II 2<sup>1</sup>/<sub>4</sub> x 2<sup>1</sup>/<sub>4</sub>" (6 x 6 cm.)

Dimensions: 5<sup>1</sup>/<sub>4</sub> x 4<sup>1</sup>/<sub>2</sub> x 1<sup>1</sup>/<sub>8</sub>" (14.7 x 11.4 x 4.8 cm.) Weight: 39 ounces (1110 grams)

Lens	Shutter	No.
Tessar f/2.8 3 <sup>1</sup> / <sub>8</sub> " (80 mm.)	Synchro-Compur	533/16 Pcms
Ever-ready case		1203/16

## SUPER IKONTA III 2<sup>1</sup>/<sub>4</sub> x 2<sup>1</sup>/<sub>4</sub>" (6 x 6 cm.)

Dimensions: 5<sup>1</sup>/<sub>2</sub> x 4 x 1<sup>1</sup>/<sub>4</sub>" (13.8 x 10.3 x 4.3 cm.) Weight: 23<sup>1</sup>/<sub>4</sub> ounces (660 grams)

Lens	Shutter	No.
Novar f/3.5 3" (75 mm.)	Synchro-Compur	531/16 Fcm
Tessar f/3.5 3" (75 mm.)	Synchro-Compur	531/16 Lcm
Ever-ready case		1237/16

## SUPER IKONTA 1<sup>3</sup>/<sub>4</sub> x 2<sup>1</sup>/<sub>4</sub>" (4.5 x 6 cm.)

Dimensions: 4<sup>1</sup>/<sub>2</sub> x 3<sup>1</sup>/<sub>8</sub> x 1<sup>1</sup>/<sub>8</sub>" (11.4 x 7.9 x 4.2 cm.) Weight: 18<sup>1</sup>/<sub>4</sub> ounces (520 grams)

Lens	Shutter	No.
Tessar f/3.5 3" (75 mm.)	Synchro-Compur	531 Lcm
Ever-ready case		1208

## SUPER IKONTA 2<sup>1</sup>/<sub>4</sub> x 3<sup>1</sup>/<sub>4</sub>" (6 x 9 cm.)

Dimensions: 6<sup>1</sup>/<sub>8</sub> x 3<sup>1</sup>/<sub>4</sub> x 2" (15.5 x 8.1 x 5 cm.) Weight: 29 ounces (820 grams)

Lens	Shutter	No.
Tessar f/3.5 4 <sup>1</sup> / <sub>8</sub> " (105 mm.)	Synchro-Compur	531/2 Lcms
Ever-ready case		1206/2

ACCESSORIES . ACCESSORIES . ACCESSORIES . ACCESSORIES . ACCESSORIES . ACCESSORIES . ACCESSORIES . ACCESSORIES . ACCESSORIES . ACCESSORIES . ACCESSORIES .

### ACCESSORIES:

	1 <sup>3</sup> / <sub>4</sub> x 2 <sup>1</sup> / <sub>4</sub> " (4.5x6 cm.)	2 <sup>1</sup> / <sub>4</sub> x 2 <sup>1</sup> / <sub>4</sub> " (6x6 cm.)	2 <sup>1</sup> / <sub>4</sub> x 3 <sup>1</sup> / <sub>4</sub> " (6x9 cm.)
ZEISS IKON precision filters in six colours	No. 353	353, 322	354
ZEISS BERNOTAR polarising filter	330	330, 331	331
ZEISS PROXAR lenses			
for close-ups down to 40" (100 cm.)	—	911/2	911/2
for close-ups down to 20" (50 cm.)	910/1	910/1, 911/1	911/1
for close-ups down to 12" (30 cm.)	910/05	910/05, 911/05	911/05
Lens hood	1111	1111, 1112	1112

### Leather case for lens hood

Cable release with lock

For 2<sup>1</sup>/<sub>4</sub> x 2<sup>1</sup>/<sub>4</sub>" SUPER IKONTA I & II

CONTAMETER Close-up rangefinder

Correction lenses for the rangefinder

Carrying strap for camera

And for all models other than the 2<sup>1</sup>/<sub>4</sub> x 2<sup>1</sup>/<sub>4</sub>" SUPER IKONTA II:

IKOPHOT exposure meter (see page 23)

1<sup>3</sup>/<sub>4</sub> x 2<sup>1</sup>/<sub>4</sub>" 2<sup>1</sup>/<sub>4</sub> x 2<sup>1</sup>/<sub>4</sub>" 2<sup>1</sup>/<sub>4</sub> x 3<sup>1</sup>/<sub>4</sub>"  
(4.5x6 cm.) (6x6 cm.) (6x9 cm.)

No. 779 779, 780 780  
1312/24 1312/24 1312/24

— 442 —  
— 901 —

— Tr. 500 —

No. 1329



# IKOFLEX



Look into the focusing screen of the IKOFLEX and you will realise the advantage of this type of camera. It shows you before you expose exactly how the subject will look. The image appears the same size as it will in the picture. It is brilliantly illuminated right to the edges. The IKOFLEX has a light-collecting Fresnel lens in place of the ordinary ground glass screen.

The large handy focusing knob sets the lens to the right distance and also incorporates a depth of field scale. You will be agreeably surprised at the outstanding clearness of the image and you can continuously check the sharpness. The folding focusing magnifier is particularly valuable for close-ups.

A safety catch on the body release prevents accidental exposures. The camera also has a double exposure lock, a film transport stop, and a film counter. In the IKOFLEX II, the film transport and shutter wind are coupled for speedier operation. All settings can be read from above. Both models are speed synchronised and the range of lenses available includes the ZEISS TESSAR f/3.5. They are all ideal for both black-and-white and colour photography.

2¼ x 2¼"

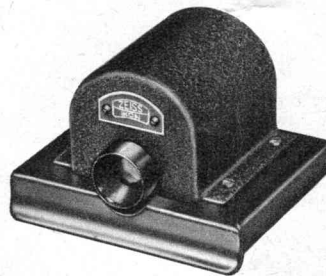

PRISM FINDER

IKOPROX



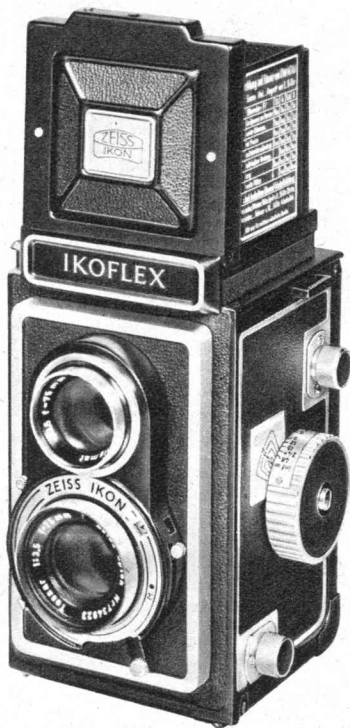

IKOFLEX Ia



Only a few accessories are necessary to turn the IKOFLEX into an extremely versatile camera. They comprise a prism finder for eye level viewing, the IKOPROX, a close-up lens unit for screen focusing of subjects down to 12 in. (30 cm.), the IKOPOL polarising filter attachment, lens hood, colour filters, etc. A special pamphlet describing these accessories is available from your dealer.



IKOFLEX IIa

IKOFLEX Ia 2 <sup>1</sup> / <sub>4</sub> x 2 <sup>1</sup> / <sub>4</sub> " (6 x 6 cm.)	Lens	Shutter	No.
Dimensions: 5 <sup>1</sup> / <sub>2</sub> x 3 <sup>3</sup> / <sub>4</sub> x 3" (14 x 9.5 x 7.7 cm.)	Novar f/3.5 3" (75 mm.)	Prontor-SV	854/16 Fpms
Weight: 34 ozs. (960 grams)	Tessar f/3.5 3" (75 mm.)	Prontor-SV	854/16 Lpms
	Ever-ready case		1224/16

IKOFLEX IIa 2 <sup>1</sup> / <sub>4</sub> x 2 <sup>1</sup> / <sub>4</sub> " (6 x 6 cm.)	Lens	Shutter	No.
Dimensions: 5 <sup>1</sup> / <sub>2</sub> x 3 <sup>3</sup> / <sub>4</sub> x 3" (14 x 9.5 x 7.7 cm.)	Tessar f/3.5 3" (75 mm.)	Synchro-Compur	855/16 Lcm
Weight: 37 ozs. (1080 grams)	Ever-ready case		1238/16

ACCESSORIES . ACCESSORIES . ACCESSORIES . ACCESSORIES . ACCESSORIES . ACCESSORIES . ACCESSORIES . ACCESSORIES . ACCESSORIES . ACCESSORIES . ACCESSORIES . ACCESSORIES .

**ACCESSORIES:**

ZEISS IKON precision filters in 6 colours	No.	
IKOPOL polarising filter attachment in leather case	371	
Lens hood	337	
Leather case for lens hood	1121	
Carrying strap for camera	780	
	Tr. 499	

**IKOPROX close-up lens unit in leather case**

for close-ups down to 20" (50 cm.)	No.	
for close-ups down to 12" (30 cm.)	937/1	
Prism finder in leather case	937/05	
Cable release with lock	400/16	
IKOPHOT exposure meter (see page 23)	1312/24	
	1329	



# CONTINA

A man of action will always choose the CONTINA. This handy miniature camera can be carried everywhere. The negative material is so cheap that you can afford to take several shots of any subject. The short focal length of the wide-aperture lenses provides great depth of field. With the red-dot zone setting, for example, everything over 8 feet from the camera will be sharp.

All settings on the CONTINA can be read from above, including the depth of field scale. The camera has an automatic film transport, double exposure lock, frame counter, film indicator, in short all the features you would look for in a modern miniature camera. The ingenious winding lever on the bottom makes for rapid film transport. The CONTINA II also has a rangefinder. This shows exactly how far the subject is from the camera and ensures accurate focusing even at the full aperture of the NOVAR or TESSAR lenses. This is specially important in colour photography.

## CONTINA I 24 x 36 mm.

Dimensions: 4<sup>3</sup>/<sub>8</sub> x 2<sup>7</sup>/<sub>8</sub> x 1<sup>3</sup>/<sub>8</sub>" (12 x 7.2 x 4.5 cm.). Weight: 16 ounces (450 grams)

Lens	Shutter	No.
Novar f/3.5 1 <sup>3</sup> / <sub>8</sub> " (45 mm.)	Pronto	522/24 Fts
Tessar f/2.8 1 <sup>3</sup> / <sub>8</sub> " (45 mm.)	Synchro-Compur	522/24 Pcm
Ever-ready case		1213/24

## CONTINA II 24 x 36 mm.

Dimensions: 4<sup>9</sup>/<sub>8</sub> x 3<sup>1</sup>/<sub>8</sub> x 1<sup>3</sup>/<sub>8</sub>" (12 x 8.2 x 4.5 cm.). Weight: 20<sup>1</sup>/<sub>2</sub> ounces (580 grams)

Lens	Shutter	No.
Tessar f/2.8 1 <sup>3</sup> / <sub>8</sub> " (45 mm.)	Synchro-Compur	524/24 Pcm
Ever-ready case		1216/24

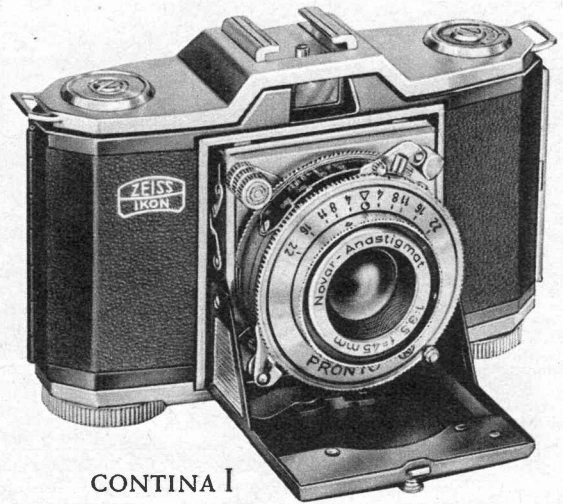

CONTINA I

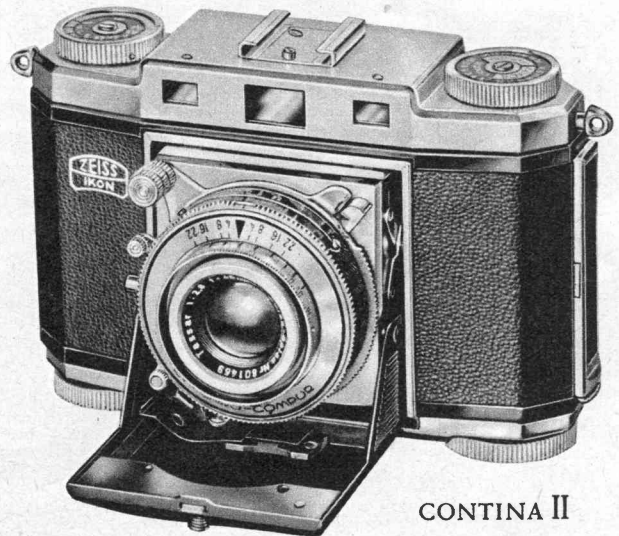

CONTINA II

ACCESSORIES . ACCESSORIES . ACCESSORIES . ACCESSORIES . ACCESSORIES . ACCESSORIES . ACCESSORIES . ACCESSORIES . ACCESSORIES . ACCESSORIES . ACCESSORIES .

### ACCESSORIES:

ZEISS IKON precision filters in 6 colours  
 ZEISS BERNOTAR polarising filter  
 Lens hood  
 Leather case for lens hood  
 Carrying strap for camera

No.  
 352  
 330  
 1110  
 778  
 Tr. 499, Tr. 500

### ZEISS PROXAR lenses (coated)

for close-ups down to 20" (50 cm.)  
 for close-ups down to 12" (30 cm.)  
 for close-ups down to 8<sup>1</sup>/<sub>2</sub>" (22 cm.)  
 Cable release with lock  
 IKOPHOT exposure meter (see page 23)

No.  
 909/1  
 909/05  
 909/03  
 1312/24  
 1329

# CONTESSA

Even the beginner will take successful pictures with the CONTESSA from the very first film. You don't have to guess distances or worry about exposures. This handy and smart miniature almost thinks for you. In addition to a coupled rangefinder, the attractive body also incorporates a photo-electric exposure meter. This is exactly matched to the CONTESSA and reliably indicates the exposure and aperture required under all lighting conditions. ZEISS IKON have more than twenty years of experience with built-in photo-electric exposure meters. The world-wide success of the CONTESSA proves the value of their achievement.

The rangefinder is combined with an optical viewfinder in one eyepiece. The CONTESSA further has a double exposure lock, automatic film transport, frame counter, rapid film winder, film indicator, a speed synchronised shutter and many other useful features. The combination of the colour-corrected and coated ZEISS TESSAR lens with the exposure meter makes every colour shot a success.

The practical accessories for the CONTESSA include the CONTAMETER close-up rangefinder. This permits hand-held shots of subjects as near as 8 inches.

Ask your dealer for the special pamphlet "The Elegant CONTESSA".

CONTESSA 24 x 36 mm.

Dimensions: 4 1/2 x 3 1/8 x 1 3/8" (11.4 x 7.8 x 4.3 cm.). Weight: 21 1/2 ounces (610 g.)

Lens	Shutter	No.
Tessar f/2.8 1 3/8" (45 mm.)	Synchro-Compur	533/24 Pcm

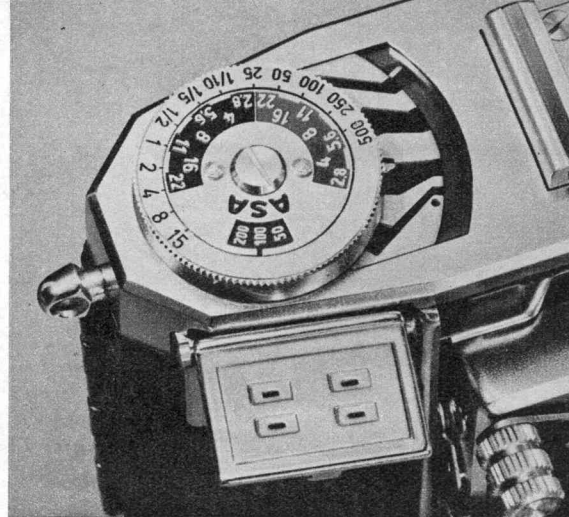

The exposure meter of the CONTESSA



24 x 36

WITH BUILT-IN

RANGEFINDER AND EXPOSURE METER

ACCESSORIES . ACCESSORIES . ACCESSORIES . ACCESSORIES . ACCESSORIES . ACCESSORIES . ACCESSORIES . ACCESSORIES . ACCESSORIES . ACCESSORIES . ACCESSORIES . ACCESSORIES .

## ACCESSORIES:

Ever-ready case	No.	1214/24
ZEISS IKON precision filters in 6 colours		352
ZEISS BERNOTAR polarising filter		330
Lens hood		1110
Leather case for lens hood		778
Carrying strap for camera		Tr. 500

## ZEISS PROXAR lenses (coated)

for close-ups down to 20" (50 cm.)	No.	909/1
for close-ups down to 12" (30 cm.)		909/05
for close-ups down to 8 1/2" (22 cm.)		909/03
CONTAMETER close-up rangefinder		441
Correction lenses for the rangefinder		901
Cable release with lock		1312/24



194

# CONTAFLEX

THE MOST ADVANCED CAMERA DESIGN OF

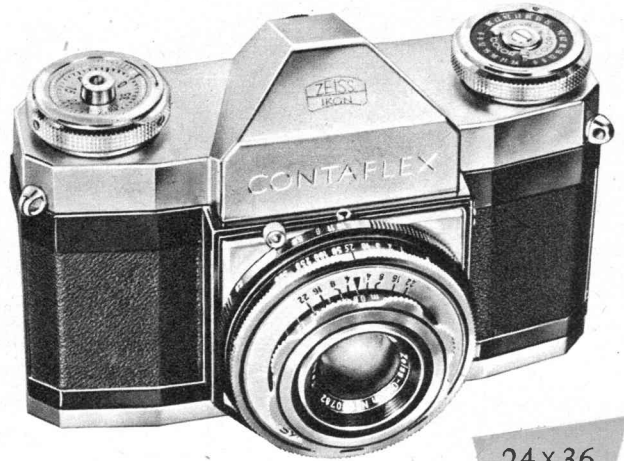

24 x 36

This is a revolutionary single-lens reflex camera with large parallax-free finder, between-lens shutter, spring-loaded pre-selector iris, split-field rangefinder and many other advantages.

**CONTAFLEX 24 x 36 mm.**

Dimensions:  $5\frac{1}{8} \times 3\frac{3}{8} \times 2\frac{5}{8}$ " (13 x 9.1 x 6.6 cm.). Weight: 23 ounces (650 grams).

Lens	Shutter	No.
Tessar f/2.8 1 $\frac{3}{4}$ " (45 mm.)	Synchro-Compur MXV with delayed action.	861/24 Pcms

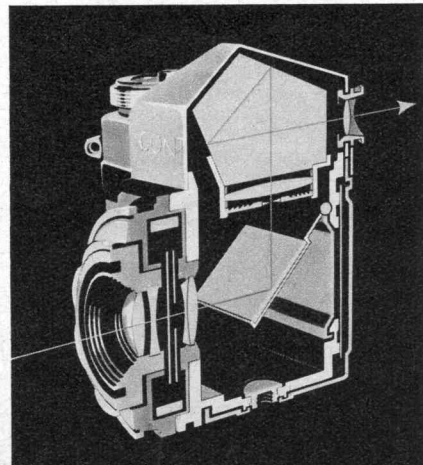

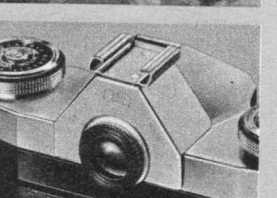
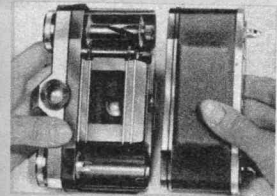

1

The CONTAFLEX finder shows the subject in almost natural size, upright, and the right way round. The image is exceptionally brilliant right into the corners and it is always sharp. You can easily follow moving subjects.—e.g. when taking sports shots or close-up action. The finder image is completely free from parallax error. Two focusing methods are available—both coupled to the lens: when the figure of the young lady is continuous (split image principle) or when her smile is clear on the screen (ground glass screen focusing), the lens is automatically set to the correct distance.

2

ACCESSORIES (see the illustrations on the left):

1 All types of flashgun can be connected to the speed synchronised Compur shutter. A right-angle plug is most suitable.

No. 1340

2 The removable back makes it a simple matter to change from black-and-white to colour film. When cassettes are used, partly exposed films can be changed in daylight.

Cassette No. 540/1

3 The film winding knob and body release combine twelve different functions. Film transport and shutter winding are coupled.

Cable release No. 1312/24

4 The ever-ready case protects the CONTAFLEX from dust and rain.

No. 1218/24

Carrying strap for camera No. Tr. 500

5

5 The case will take two colour filters which are available in six colours.

No. 352

Lens hood No. 1110

Leather case for lens hood No. 778

6

6 For close-ups at 20, 12, and about 8" (50, 30, and 20 cm.) you only have to clip ZEISS PROXAR lenses over the camera lens. You select the field of view and check the sharpness in the finder in the normal way. PROXAR lenses (coated)

No. 909

7

7 Accessory shoe for flashguns No. 861/02

Further ACCESSORIES:

To fit the CONTAFLEX to the CON-TAX copying outfits an attachment head is used.

No. 861/01

Right-angle telescope for finder 1253

CONTAPOL polarising filter 338

Correction lenses for finder 902

IKOPHOT exposure meter (see page 23) 1329

Two lens attachments for portraiture and stereo photography are in preparation. No special finder is required for them.

out of focus

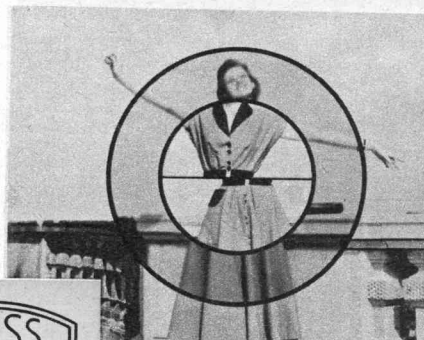

in focus

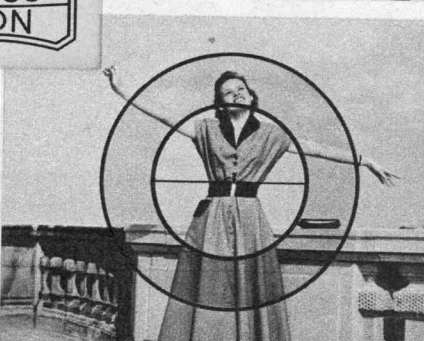

A detailed folder is available from your dealer

# CONTAX IIa

Nearly every photographer would like to be able to cover all fields, to be master of any situation with a single camera. That is the secret of the world-wide popularity of the leading ZEISS IKON product, the famous CONTAX. This perfected miniature camera can tackle any job. Its ultra-fast f/1.5 lens will take instantaneous shots in the poorest light, while the top shutter speed of  $1/1250$  second will capture the fastest sports subject. Its scope extends from telephoto and wide angle shots with the world famous ZEISS lenses to the

scientific macrophotographs taken with the various close-up attachments. Flash photography presents no problems, either for the CONTAX with its fully synchronised all-metal focal plane shutter. All shutter speeds are set on a single disc and the setting automatically adjusts the synchronisation for electronic flash or long-peak focal plane flash bulbs. You only have to connect the flashgun to the flash socket; the CONTAX does the rest.

To mention just a few of the many technical features: the CONTAX has a combined range and viewfinder coupled to the lens, coupled film transport and shutter winding, adjustable delayed action, removable back, and so on. A separate pamphlet contains detailed information. The CONTAX IIIa also has a built-in photoelectric exposure meter.



24x36

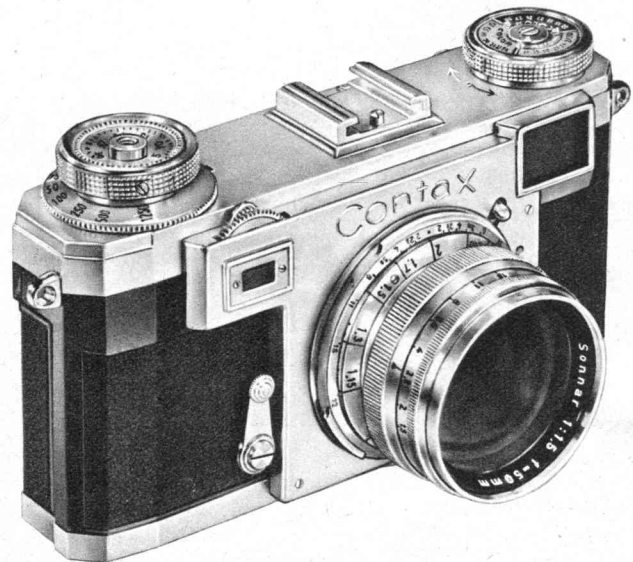

ACCESSORIES . ACCESSORIES . ACCESSORIES . ACCESSORIES . ACCESSORIES . ACCESSORIES . ACCESSORIES . ACCESSORIES . ACCESSORIES . ACCESSORIES . ACCESSORIES . ACCESSORIES .

## ACCESSORIES:

Rangefinder attachment for 85 and 135 mm. lenses.

Multiple finder for 85 and 135 mm. lenses

Leather case for multiple finder

Universal finder with leather case

Wide angle finder for 35 mm. lenses

Wide angle finder for 21 mm. Biogon

Correction lenses for rangefinder

No.

563/03

438

773

440

432/5

435

901

Cable release with lock

Ever-ready case for CONTAX IIa and IIIa

Hold-all case

Omnica universal case

CONTAX cassette with spool and box

Carrying strap for camera

Leather bags and leather cases for all CONTAX lenses.

See special pamphlet.

No.

1312/24

1215/24

1240/24

1241/24

540/1

Tr. 500

# IIIa



The bayonet mount makes lens changing particularly simple and quick with the **CONTAX**. The lenses are perfectly colour corrected and coated and have proved their worth with black-and-white and colour shots under the most difficult conditions all over the world.

A wide range of accessories is available for many special purposes. The **CONTATEST** permits close-ups to 20 in. (50 cm.) and the **CONTAMETER** down to about 8 in. (20 cm.). The new **STEREOTAR** attachment serves for stereo photographs. Several copying outfits with focusing adaptors, extension tubes etc., are provided for scientific work. These various attachments which together with the lenses form the unique **CONTAX SYSTEM**, are also fully described in the special pamphlet.

### CONTAX IIIa 24 x 36 mm.:

Dimensions: 5<sup>1</sup>/<sub>4</sub> x 3 x 1<sup>1</sup>/<sub>2</sub>" (13.4 x 7.5 x 3.6 cm.)

Weight of body: 18<sup>1</sup>/<sub>4</sub> ounces (520 grams)

Lens	No.
Tessar f/3.5 2" (50 mm.)	563/24 L
Sonnar f/2 2" (50 mm.)	563/24 N
Sonnar f/1.5 2" (50 mm.)	563/24 J

### CONTAX IIIa 24 x 36 mm.:

Dimensions: 5<sup>1</sup>/<sub>4</sub> x 3<sup>1</sup>/<sub>4</sub> x 1<sup>1</sup>/<sub>2</sub>" (13.4 x 8.3 x 3.6 cm.)

Weight of body: 21<sup>1</sup>/<sub>4</sub> ounces (600 grams)

Lens	No.
Tessar f/3.5 2" (50 mm.)	564/24 L
Sonnar f/2 2" (50 mm.)	564/24 N
Sonnar f/1.5 2" (50 mm.)	564/24 J

### The interchangeable CONTAX lenses:

Lens	No.
Biogon f/4 5 <sup>5</sup> / <sub>8</sub> " (21 mm.)	563/013 A
Planar f/3.5 1 <sup>1</sup> / <sub>8</sub> " (35 mm.)	563/014 B
Biogon f/2.8 1 <sup>1</sup> / <sub>8</sub> " (35 mm.)	563/09 T
Tessar f/3.5 2" (50 mm.)	543/00 L
Sonnar f/2 2" (50 mm.)	543/59 N
Sonnar f/1.5 2" (50 mm.)	543/60 J
Triotar f/4 3 <sup>3</sup> / <sub>8</sub> " (85 mm.)	543/02 K
Sonnar f/2 3 <sup>3</sup> / <sub>8</sub> " (85 mm.)	563/05 O
Sonnar f/4 5 <sup>5</sup> / <sub>8</sub> " (135 mm.)	543/64 R

24 x 36

ACCESSORIES . ACCESSORIES . ACCESSORIES . ACCESSORIES . ACCESSORIES . ACCESSORIES . ACCESSORIES . ACCESSORIES . ACCESSORIES . ACCESSORIES . ACCESSORIES . ACCESSORIES .

ACCESSORIES:	No.
CONTATEST Optical Close-up Focusing Attachment	443
CONTAMETER Optical Close-up Rangefinder	439
CONTAPROX I Close-up Adaptor	1450
CONTAPROX II Close-up Adaptor	1451
PANFLEX reflex attachment	5522/23
Table Copying outfit	1403
For the portable and large copying outfits see special pamphlet.	

STEREOTAR stereo attachment	No. 810
Stereo finder for Stereotar	420
Stereo PROXAR lens set for 20, 12 and 8" (50, 30 and 20 cm.)	925
Leather case for Stereotar, finder and Proxar lenses	1243
Stereo mask assortment (Set of 50)	1503
A special pamphlet deals with all lenses, filters, lens hoods and PROXAR lenses, polarising filters etc.	



# MOVIKON 8

horizontal

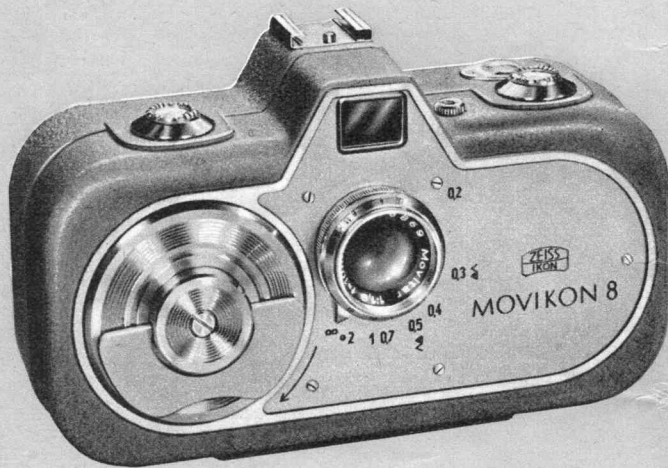

For a living record of events around you, there is only the motion picture projected on a screen. You re-experience memories of happy holidays, day-by-day happenings, or important occasions at home and with friends. You are your own film director, and your family the film stars—this is a pastime providing many long hours of fun. And yet filming is even simpler than photography. You realise that as soon as you get hold of the HORIZONTAL MOVIKON 8. You just set the aperture. If you film in colour you will use the IKOPHOT (see page 23), and the camera is ready to run. No focusing is necessary except for close-ups since the short focal length of the fast 10 mm MOVITAR f/1.9 lens has an extraordinarily great depth of field. For example, when set to 3 feet and aperture f/8, everything will be sharp from 20 in. to infinity.

Because of its horizontal shape the MOVIKON 8 is easy to hold really steady in both hands, just like the CONTAX. The index finger conveniently operates the handy release. The large and bright optical finder clearly shows the correct field of view. For close-up shots—the lens can be focused down to 8 in. (20 cm.)—optical parallax compensation is provided. You get perfect takes in any situation without trouble.

Further advantages of this handy narrow-gauge cine camera are red-dot focusing zones, a safety lock against accidental release, a running lock so that you can film yourself, single frame exposures, an automatic film counter and removable back. The full versatility of the MOVIKON 8 is realized by the MOVIKON SYSTEM, which is described on the following page.

HORIZONTAL MOVIKON 8: Dimensions  $5\frac{3}{4} \times 2 \times 3\frac{3}{8}$ " (14.5 x 5 x 8.5 cm.). Weight:  $34\frac{1}{2}$  ounces (980 grams) With 10 mm. Movitar f/1.9

No. 5532/288.



ACCESSORIES . ACCESSORIES . ACCESSORIES . ACCESSORIES . ACCESSORIES . ACCESSORIES . ACCESSORIES . ACCESSORIES . ACCESSORIES . ACCESSORIES . ACCESSORIES . ACCESSORIES .

## ACCESSORIES:

Ever-ready bag of soft leather	No. 775
Ever-ready case	1280/28
ZEISS IKON precision filters in six colours	361
MOVIGONAR wide angle attachment with finder and lens hood in case	5532/07
MOVITELAR tele attachment with finder and lens hood in case	5532/06

MOVITRIX Titler	No. 1426/28
Cone hood for Movitrix	1426/05
MOVILUM Universal lighting outfit with two lamps and switch, but without bulbs (for accessories see page 22)	1310
MOVISCOP Film editor	1431/28
For further accessories see special pamphlet IKOPHOT exposure meter (see page 23)	1329

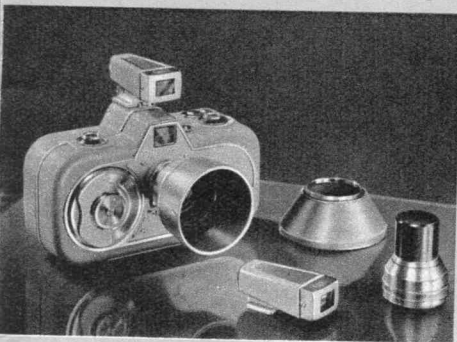

*MOVITELAR and MOVIGONAR  
lens attachments*

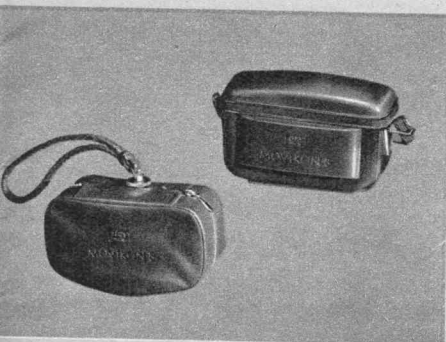

*Ever-ready bag and Ever-ready case*

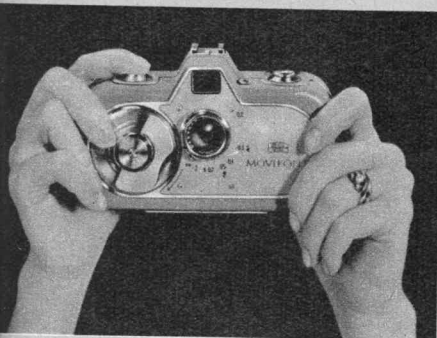

*Convenient horizontal hold*

## THE MOVIKON - SYSTEM

Large views of distant subjects are impossible if you cannot get sufficiently close. With the MOVIKON 8 however you simply screw the MOVITELAR attachment on to the standard lens and you see the subject as if through a telescope. The effective focal length is doubled (20 mm.) but the aperture still remains at  $f/1.9$ . The accessory finder shows the correct field of view and a special lens hood cuts out stray light.

A lens attachment is also available for wide-angle shots. This is the MOVIGONAR and is supplied in a case complete with finder and lens hood. It reduces the effective focal length to 5 mm. keeping the aperture constant.

Films must of course be titled. The MOVITRIX multipurpose titler is a really versatile piece of equipment for this purpose. Running titles, drum titles or flap-overs are as simple to make as titles in front of a moving background. The cone acts as a special lens hood and can also be used as a matte box for normal filming.

Artificial light shots are best taken with the MOVILUM lighting unit.

It is firmly attached to the MOVIKON and can be equipped with four or six reflectors to light up large rooms. It can also be attached to the MOVITRIX to illuminate titles evenly.

The film becomes suitable for projection only if the individual scenes are spliced together in the correct order. The MOVISCOP 8 film editor, which is also made for 16 mm. film, shows the picture animated. A marker is provided to indicate cuts and the base-board can also be used for rewinding the film after projection.

For details see the special pamphlet on the  
HORIZONTAL MOVIKON 8

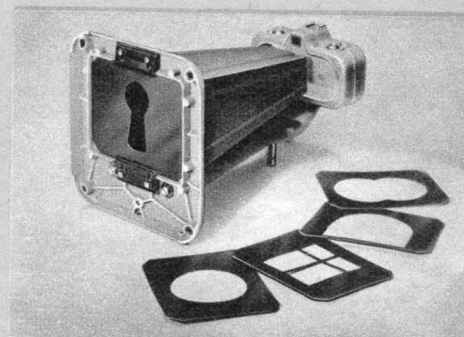

*MOVITRIX with cone as matte box*

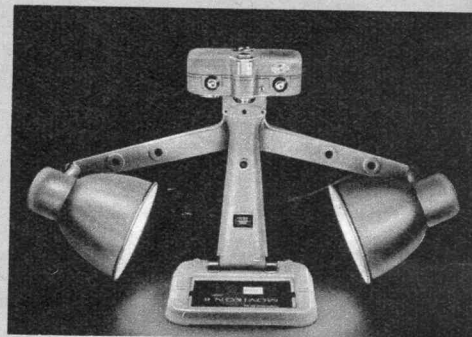

*MOVITRIX with MOVILUM  
lighting unit*

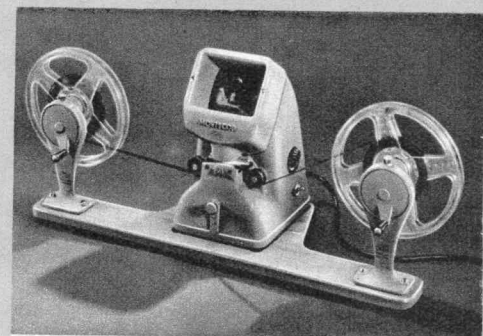

*MOVISCOP film editor*

# IKOBLITZ

At dusk or for indoor shots the light may become insufficient for a snapshot. Here ZEISS IKON flashguns provide the solution. They are connected to the synchronised flash socket fitted on all ZEISS IKON cameras. The new IKOBLITZ is an especially neat and handy piece of apparatus containing a test lamp for testing the flash bulb. It folds up, and when carried in the case supplied, it takes up next to no room. It is suitable for all flash bulbs with S.C.C. cap.

The IKOBLITZ III is a bigger version for flash bulbs with Edison and S.C.C. caps. Like the smaller model it is a capacitor unit. The IKOBLITZ III can be used with several extension units to light up large rooms.

IKOBLITZ with cable and case No. 1316      IKOBLITZ without cable No. 1369  
 Accessories for IKOBLITZ III: Connecting cable 18" (45 cm.) long, Cat. No. 1356/02; 3 ft. (90 cm.) long, Cat. No. 1356/03. Adaptor with ejector for small S.C.C. bulbs, Cat. No. 1356/01.  
 Connecting cable for extension gun 3 ft. (90 cm.) long, Cat. No. 1356/011.

# MOVILUM

The MOVILUM universal lighting unit (see also page 21) can be attached to any camera by means of a bracket. You don't stumble any more over lamp stands and cables when you move the camera about. The reflectors can be adjusted individually.

MOVILUM with two reflectors, without bulbs	No. 1310
Camera bracket	No. 1310/01
Rubber handle	No. 1310/02
Two additional reflectors, without lamps	No. 1310/03

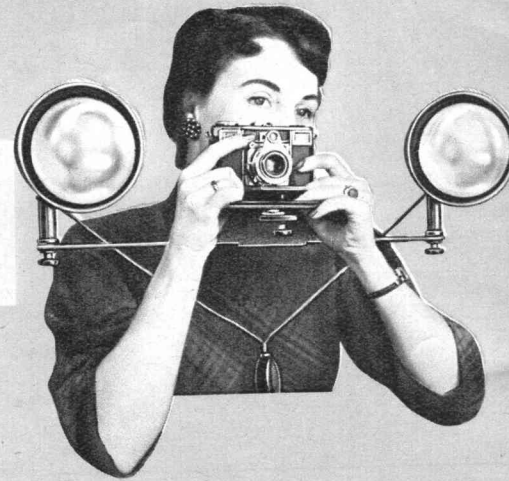
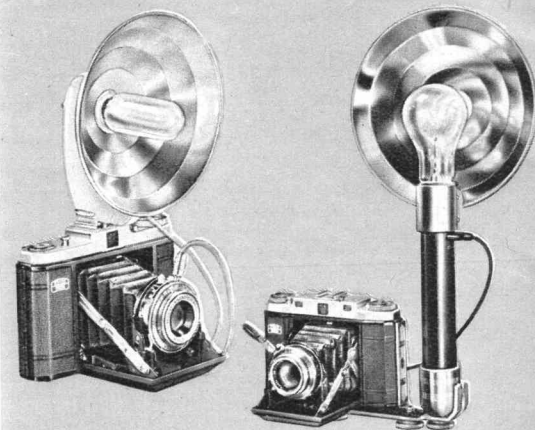

# IKOTRON

You will be completely independent with the IKOTRON electronic flashgun, since its source of electricity is a dry battery with a capacity sufficient for 2000 flashes. This robust unit requires no servicing or recharging of accumulators. Rapid successive flashes and complete absence of noise make the operation of the IKOTRON specially convenient. The brief flash of  $1/2000$  sec. ensures sharp pictures of the fastest action subjects. Accessories such as the synchronised distant release are described in a special pamphlet.

IKOTRON electronic flash unit, complete

No. 1314

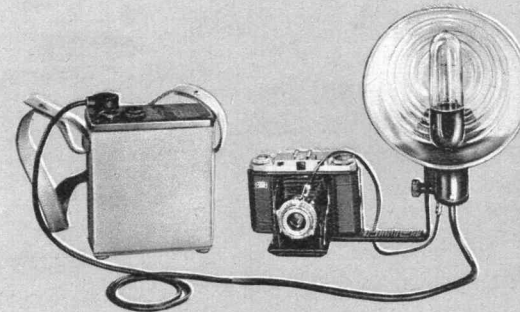



# IKOPHOT

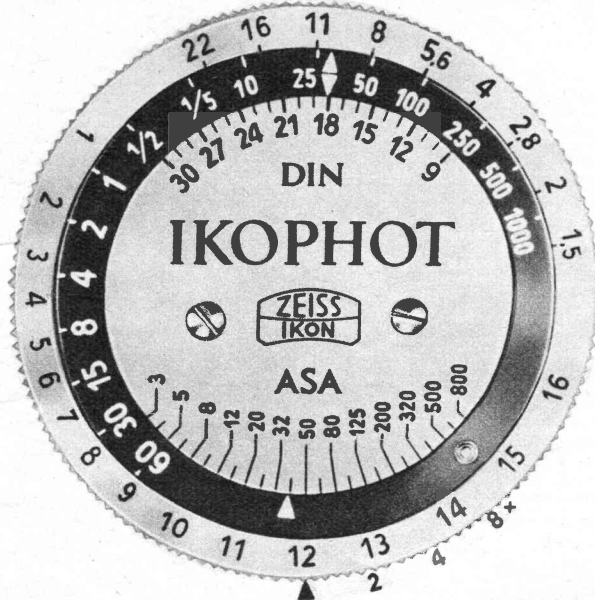
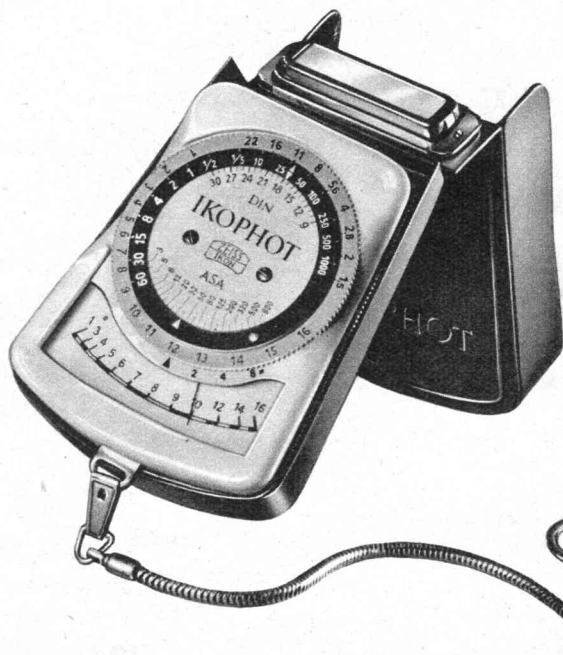

Even an experienced camera man can easily slip up in estimating the exposure. He therefore uses a photo-electric exposure meter. This is simply indispensable for colour photography since even a slight error in exposure will falsify the colours. The IKOPHOT is equally suitable for black-and-white and colour photography. Its novel calibration takes care of the special properties of reversal film. The sensitivity of the film may be set in DIN or ASA degrees.

The IKOPHOT is operated with one hand and the exposure time for any one lens aperture can be read off immediately. Even with filters no calculation is necessary. A special index mark shows the readings for cine work.

Its wide range reliably covers brightness values from brilliant sunlight in the mountains to dim and narrow streets. Under difficult lighting conditions the diffusing disc helps to measure the incident light on the scene. The moisture proof ivory coloured case protects all sensitive parts. Its elegant ever-ready case of rust leather and the gilt safety chain turn the IKOPHOT into the gem of every photographic equipment.

IKOPHOT photo-electric exposure meter with diffusing disc, ever-ready case and safety chain

No. 1329



*Zeiss Ikon cameras call for the genuine Zeiss Ikon accessories.*

- Colour filters** ZEISS IKON precision colour filters screw or push onto the lens and can stay in place even with the camera closed. They are produced under strict optical control so as to preserve the outstanding performance of the world famous lenses built into ZEISS IKON cameras. They are available as yellow, yellow-green, orange, red, UV and blue (IKOLOR) filters.
- Polarising filters** The ZEISS BERNOTAR tones down undesirable reflections from shiny surfaces in the picture and is also valuable for colour photography.
- Lens hoods** They prevent flare when photographing against the light and protect the lens from snow and rain.
- Supplementary lenses** The ZEISS PROXAR lenses bring the camera to within 12 in. (30 cm.) of the subject—in some cases even down to 9 in. (22 cm.).
- Cable release** For slow instantaneous and time exposures with lock for long exposure times.

Your dealer will be glad to demonstrate all ZEISS IKON cameras without obligation.



Available  
at  
N. A. A. F. I. STORES  
R. A. F. AMMAN  
at  
N. A. A. F. I. PRICES